

hd ML24Beam

Beamforming Loudspeaker

The **hd ML24Beam** is equipped with 24 shielded 2" fullrange speakers, each with 75 W amplifiers and the latest DSP generation. It offers great potential for improving the sound distribution in complex architectures and strongly reverberant rooms. The goal is to focus the sound only on auditory surfaces, while surfaces that cause unwanted reflections and generate disturbing diffuse sound to be shaded. This leads to a much better speech intelligibility and a first-class listening experience for every listener, allows an inconspicuous positioning of the speakers in previously inappropriate positions, as well as a flexible adaptation of the speaker radiation characteristics to different applications.

The hd ML24Beam is free of interference in the important mid-frequency range thanks to the true 1-way design, as there is no shadowing from superior speakers, and no crossover network adversely affects the radiation, enabling clean implementation of beamforming algorithms. The result is an extremely homogeneous horizontal radiation of 100° and outstanding sound quality for speech and music, extended dynamics.

The specially developed electronic unit features a high-performance DSP, which exploits all possibilities of modern signal processing to realize extensive beamforming algorithms. Using the intuitive software hd LevelZ, the sound field can be simulated and optimized to achieve the best possible result.

The ultra compact width of 80mm makes the hd ML24Beam the narrowest beamforming speaker on the market, which is almost invisible in fixed installations. The electronic unit is integrated into the housing of the loudspeaker and is optimally protected by the continuous fine-structured design grid with backed acoustic foam and ensures an unobtrusive integration into any room architecture. The continuous metal rail on the back of the aluminum profile allows the use of M6 square nuts for attaching a wall mounting adapter or the use of the tripod adapter for mobile applications. M6 threads on the top and bottom allow wall mounting with L mounting brackets in the smallest space requirement.

hd ML24Beam datasheet



Daimler AG, TECFABRIK, Sindelfingen

DSP Electronic Features

- 2In/24Out High-End hd BeamDSP with more than 300 MIPS
- redundant input section with fallback algorithm
- analog + digital inputs with Dante*
- AdvancedDirectivityOptimization algorithm
- AdvancedRoomOptimization algorithm
- 384 taps FIR filter per input / output
- 16x IIR (double precision) filters per input/output
- 75W Class-D amplifier with digital control for best SNR
- ImpedanceControl with error detection
- multi-stage limiter architecture (Peak/RMS/Thermal)
- hd LevelZ remote software via USB



*Dante optional

Acoustic & Mechanical Features

- true 1-way design
- shielded 2" fullrange speakers
- Standard colors: RAL 9005 & RAL 9010
- narrowest width of 80 mm
- precise, even sound emission
- high sound pressure
- excellent speech intelligibility
- discreet room integration
- HiFi sound

Applications

Restaurants, Bars, Airports, Train Stations, Home Theater, Conference Rooms, Hotels, A/V Installations, Multimedia Applications, Meeting Rooms, TV Studios, Churches, Lecture Halls, Museums, Sports Venues, Live Events, Broadcast

Model	hd ML24Beam
Order number	400102
Acoustic design	active Beamforming speaker
Transducers	24x 2" fullrange chassis
max. Beam Count	3
Amplifiers	24x 75 W
Coverage hor	100°
Coverage ver	0° - 90°, ± 60° adjustable (0.1°/step)
Frequency range (-6dB)	110 Hz - 20 kHz
SPLmax @ 10% THD	125 dB
Features	AdvancedDirectivityOptimization AdvancedRoomOptimization redundant input section with 2x analog inputs and fallback algorithm limiters
Enclosure	powder-coated aluminum profile black (RAL 9005) or white (RAL 9010), steel grille with acoustic foam, 2x M6 thread in the cover / bottom, rear connection panel with Phoenix 3-pin network, Phoenix 6-pole audio, USB
Optional Accessories	Dante (Art. 400140) various Wall mount RAL color (Art. 1071) Special length
Weight	12 kg
Dimensions (W x H x D)	80 x 2413 x 78 mm

Beamforming Features

BeamControlParameter

Beam Steering.

Beam steering is the basic discipline of beam forming where the main lobe is digitally steered up- or downwards. Harmonic Design® Beamforming loudspeakers are capable to adjust the vertically main lobe beam angle up to $\pm 60^\circ$ with an accuracy of $0.1^\circ/\text{step}$.

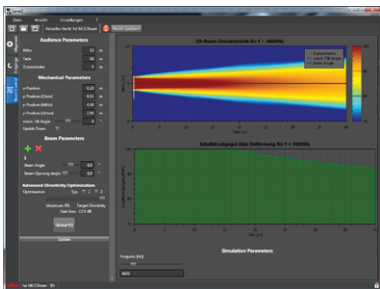

main beam @ 0°

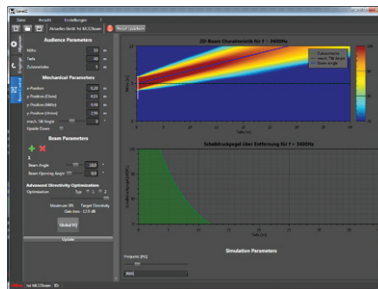

main beam @ $+10^\circ$

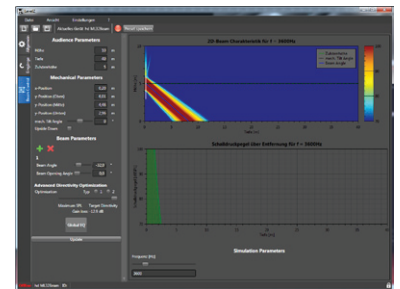

main beam @ -32°

Frequency Independent Opening Angle.

Conventional loudspeaker arrays increase their directivity with increasing frequency resulting in a wide main lobe at low frequencies and a narrow main lobe at high frequencies. A frequency independent opening angle preserves the same opening angle over a great bandwidth within physical limitations and is adjustable from minimum to 90° in 0.1° steps. This guarantees perfect concentration of sound where it belongs and where not.

f = 800 Hz

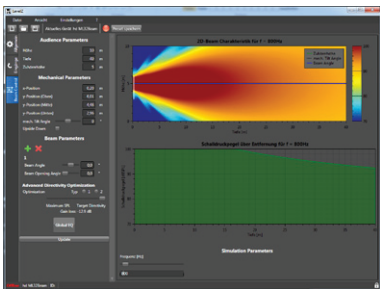

f = 2 kHz

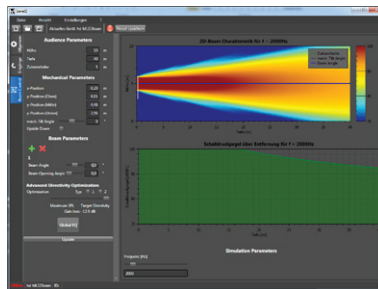

f = 4 kHz

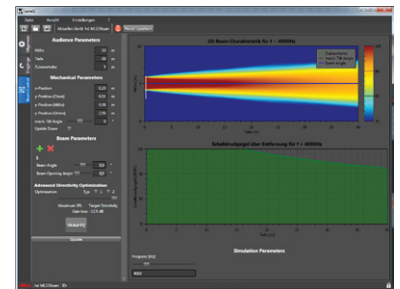

conventional main beam

frequency independent opening angle $\theta = 30^\circ$

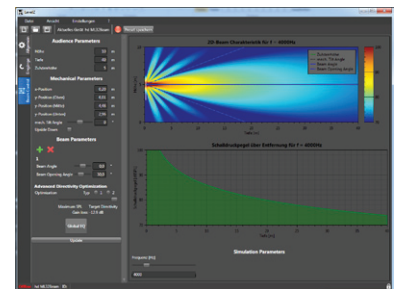
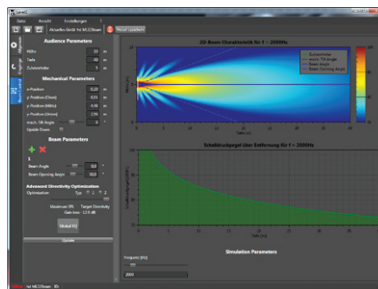
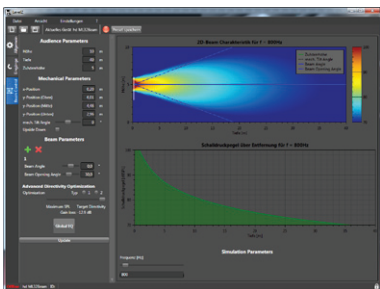

hd ML24Beam datasheet

Multiple Beams.

The unique Harmonic Design® Algorithm enables up to 4 separate main beams that can be steered individually and still create a specific frequency independent opening angle.

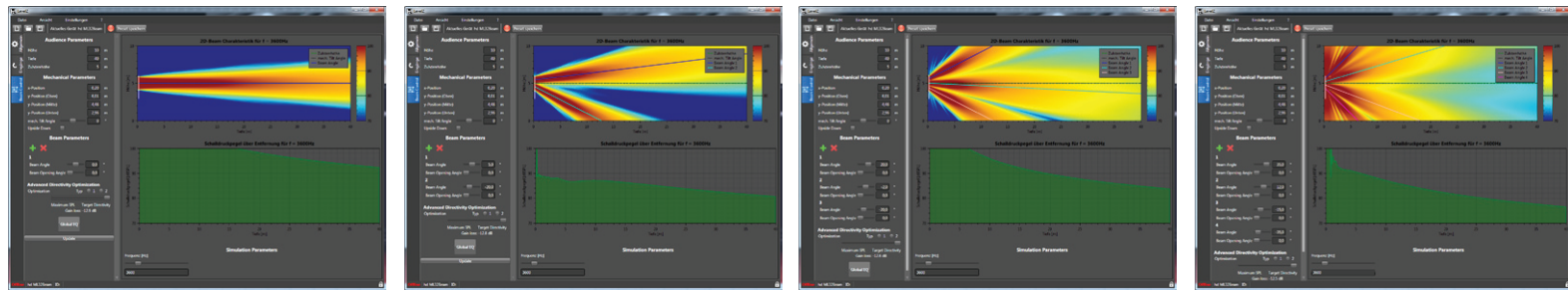

main beam @ 0°

2 beams @ +5° | -20°

3 beams @ +20° | -2° | -20°

4 beams @ 35° | +12° | -12° | -35°

AdvancedDirectivityOptimization.

The conventional beam radiation pattern also contains unwanted side lobes that excite the auditorium with disturbing noise while declining the speech intelligibility. By applying special algorithms to the individual DSP channels, an almost optimum, light-beam-like main lobe beam is achievable with an accurate side lobe suppression. The enhancements to improve speech intelligibility in reverberant rooms by applying ADO algorithm are extreme. The strength of the optimization tool may be adjusted by the end-user either towards maximum SPL or optimum target directivity.

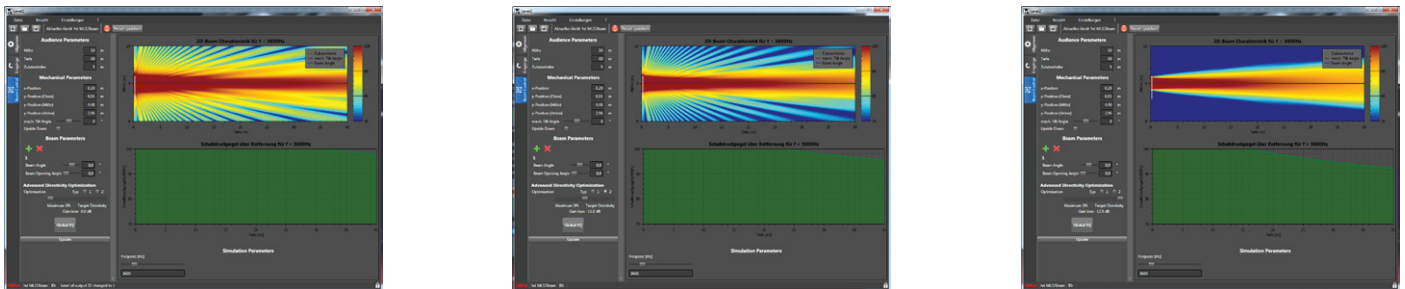

conventional beam pattern, ADO off

intermediate ADO

maximum ADO

Focus.

By default the focus point of the wave fronts of the individual loudspeakers is infinity and creates parallel running pressure waves. At the distance infinity all wave fronts are perfectly correlated and coherent meaning they arrive at the same time with the same relative phase. Whenever this large throw is not necessary it may be useful to focus the wave fronts to the front rows in steps of 0.1m to tighten the „sweet spot“ .

hd ML24Beam datasheet

Dimensions [mm]

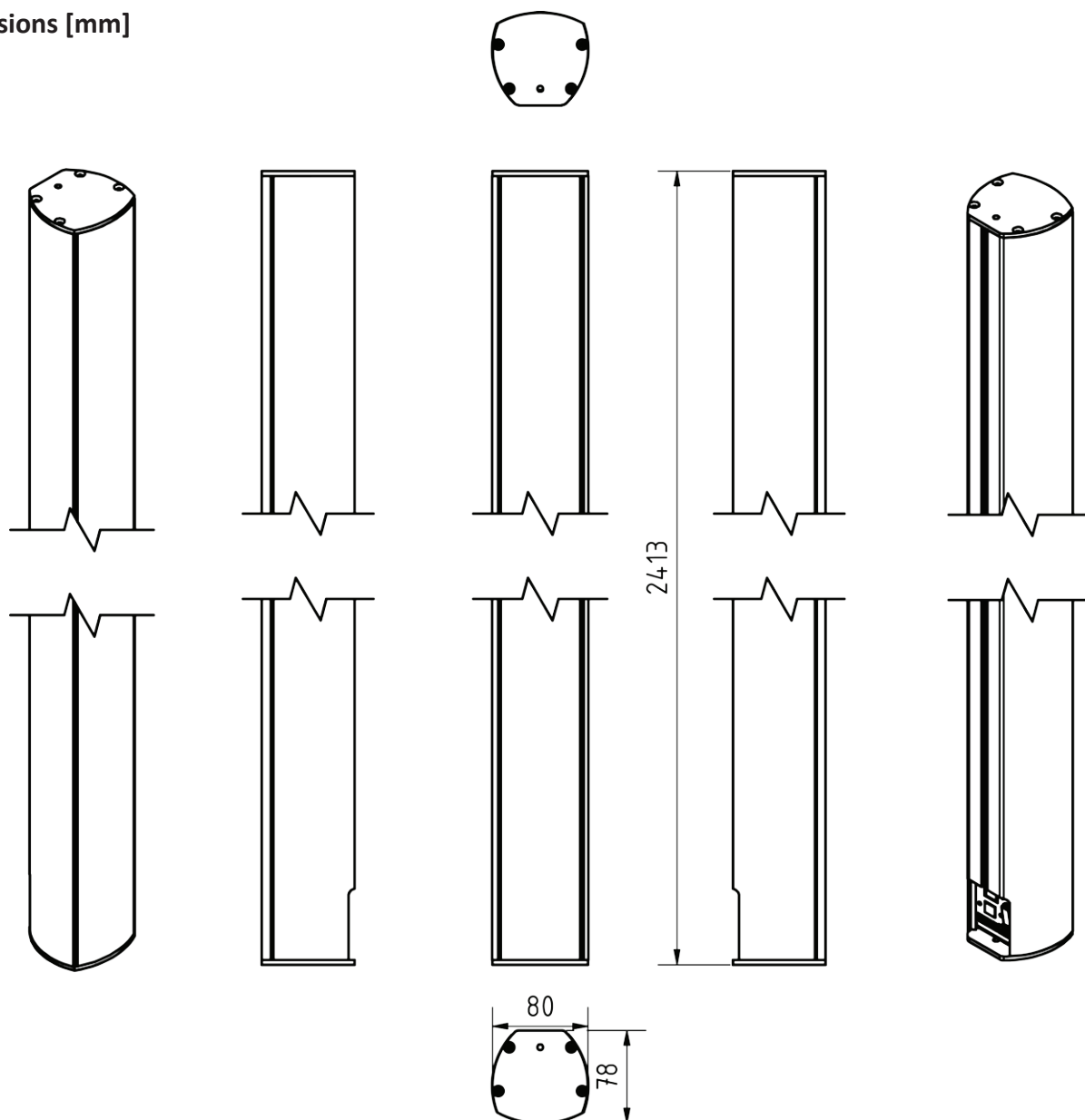

Horizontal Isobars

Horizontal isobars: hd ML24Beam

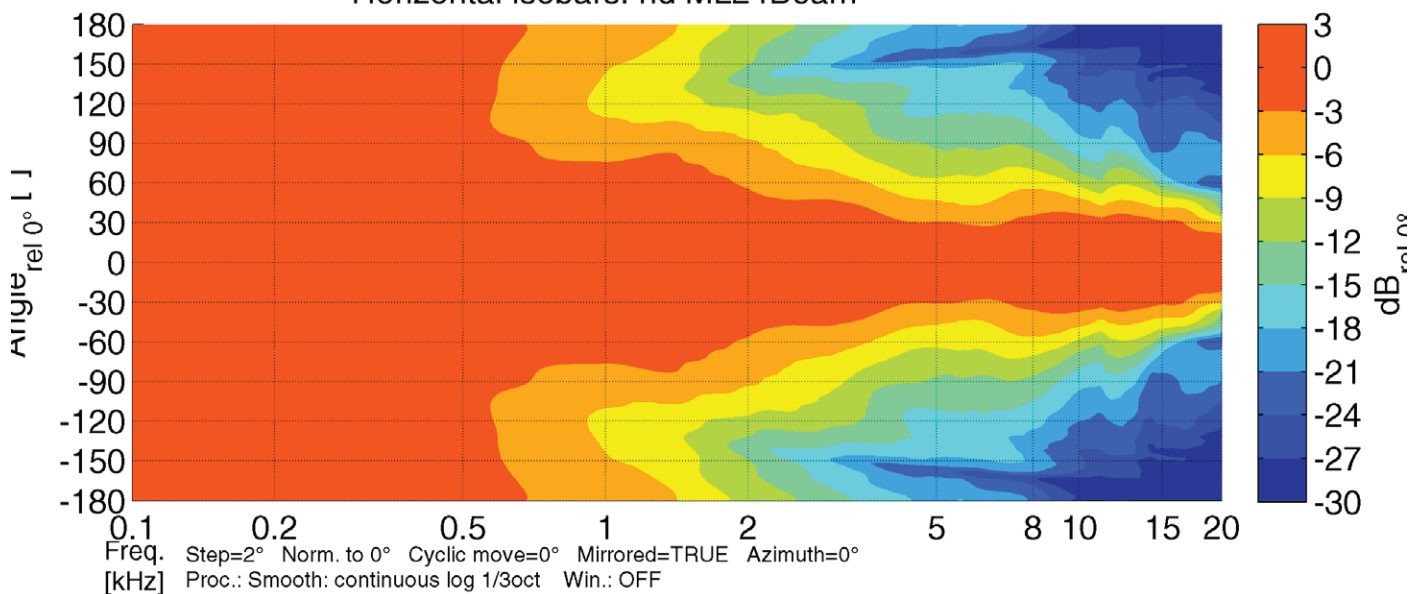

hd ML24Beam datasheet

Accessories

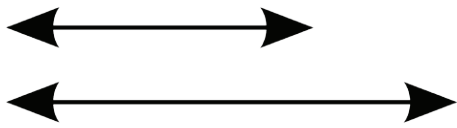

Special length

Special length of the speaker according to customer requirements

Order number: 40711 (up to 2000 mm total length)
40714 (up to 3000 mm total length)

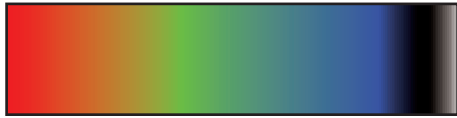

RAL color

Special color per article according to RAL color chart

Order number: 1071



Dante

1 Ch digital audio stream over Dante network via PoE, replacing the primary analog input

Order number: 400140



Mounting adapter for mobile applications

Use with tripod adapter 19780 for easy and quick installation with two thumbscrews in mobile applications

Order number: 900851 (black RAL 9005)



Tripod adapter 19780

Tripod adapter for tilting up to 30° on a 35 mm tripod

Load capacity: 15 kg
Dimensions (W x H x D): 59 x 87 x 131 mm
Order number: 900856 (black RAL 9005)



Wall mount 24471

Wall distance 110 mm, laterally swiveling with inclination up to 30°

Load capacity: 15 kg
Dimensions (W x H x D): 90 x 160 x 110 mm
Order number: 900851BLK (black RAL 9005)
900851W (white RAL 9010)

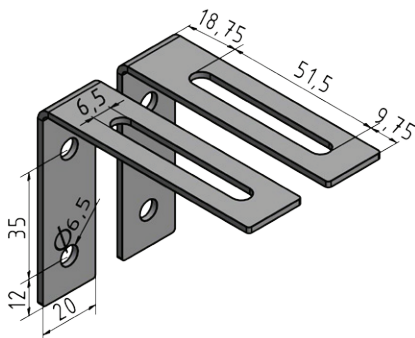

L-bracket wall mount-set

Discreet L-bracket set for extremely close mounting of the speaker to the wall. Side swivel with inclination up to 5°. The speakers housing plates are equipped with M6 inlet threads. Incl. 2x M6x14 hexagon socket screws

Load capacity: 30 kg
Dimensions (W x H x D): 20 x 60 x 80 mm
Order number: 900106 (in RAL color of speaker)