



hd M2

PointSource Stick

The **hd M2** is a passive 1-way design speaker, equipped with two 2" fullrange chassis, which is ideal for near field or voice applications. It can be powered by any power amplifier with DSP or hd system amplifiers, making the hd M2 the ideal solution for decentralized or small sound applications such as restaurants, conference rooms or theaters. The hd M2 can be flexibly and easily installed permanently or can be used as a mobile device. Using the discreet ball joint wall mount, the hd M2 can be easily swiveled and tilted or attached to the surface to be fixed extremely close and unobtrusive with the L-angle wall mount. Internal clamping connections ensure a tool-free and quick connection of the loudspeakers. For optimum adaptation to the room architecture, the loudspeaker can be customized in all RAL color and special length. If wall mounting is not possible, the speakers can be used with the optional 3/8" threaded base plate and SpeakON jack on a microphone stand.



Features

- PointSource in column format
- Operation with any amplifier
- Frequency and phase optimization integrated
- elegant design
- precise, even sound emission
- Coverage pattern 100° x 50°
- excellent speech intelligibility
- 100V version available

Applications

Restaurants, Bars, Airports, Train Stations, Home Theater, Conference Rooms, Hotels, A/V Installations, Multimedia Applications, Meeting Rooms, TV Studios, Churches

Model	hd M2
Order number	40100
Acoustic design	PointSource
Transducers	2x 2" fullrange chassis
Impedance	8 Ω
Coverage (hor x ver)	100° x 50°
Frequency range (-6dB)	170 Hz - 22 kHz
Sensitivity (1W / 1m)	89 dB
Power Rating AES / Peak	50 / 70 W
SPLmax @ 10% THD	113 dB
Enclosure	powder-coated aluminum profile black, steel grille with acoustic foam, connection terminal inside, cable inlet rear, incl. 2x M6 nuts
Optional Accessories	Speakon NL4 (Art. 900109) 3/8"- inlet thread + NL4 (Art. 900107) 35 mm flange + NL4 (Art. 900857) RAL color, wall mount, special length, weather protection, 100V
Weight	2 kg
Dimensions (W x H x D)	80 x 205 x 78 mm



...simply harmonic sound

hd M2 datasheet

Dimensions [mm]

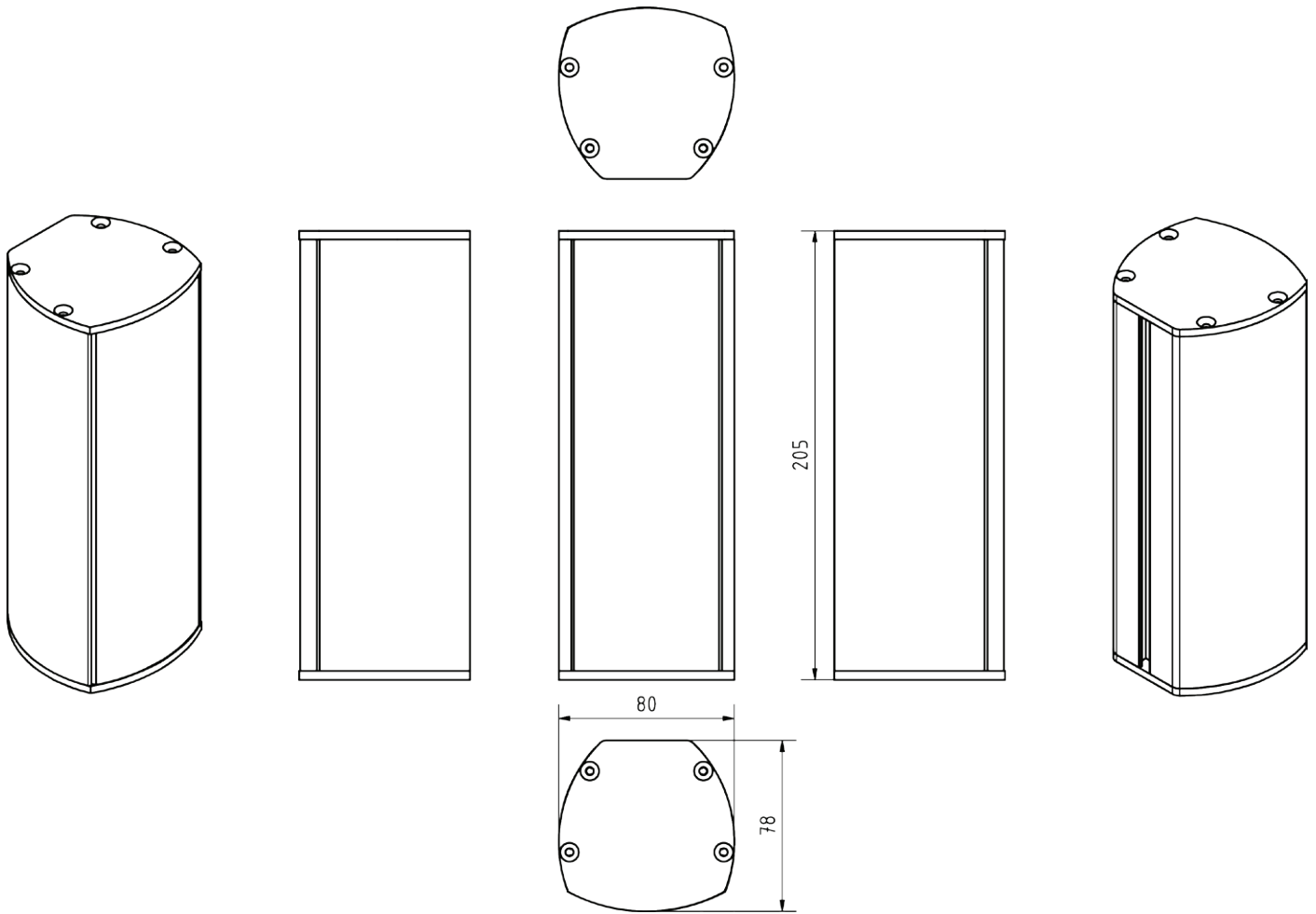

Impedance

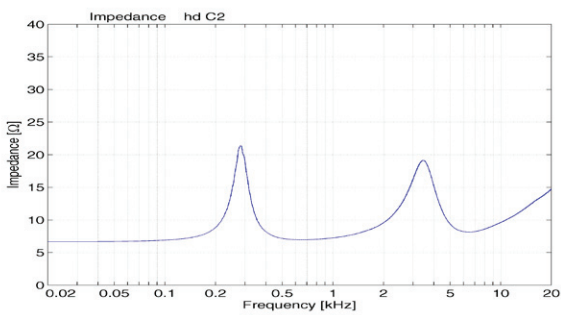

Horizontal Isobars

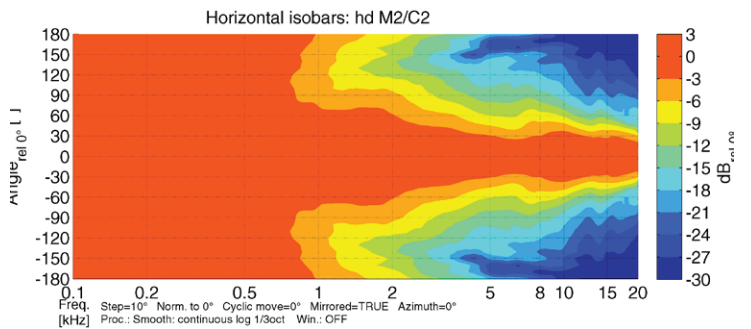

Frequency response with DSP preset

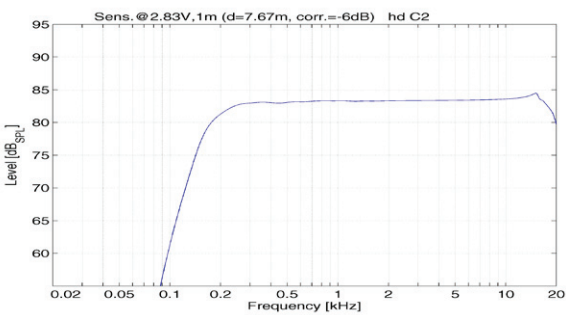

Vertical Isobars

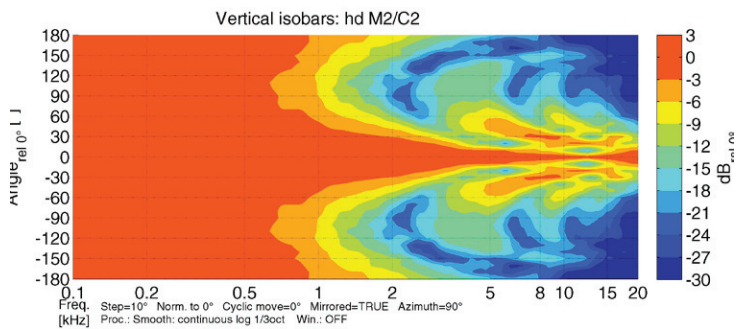

hd M2 datasheet

Accessories



Special length

Special length of the speaker according to customer requirements

Order number: 40710 (up to 1000 mm total length)
40711 (up to 2000 mm total length)



RAL color

Special color per article according to RAL color chart

Order number: 1070



Weather resistant

Impregnation against weather influences

Order number: 4610



100V-Transformer

integrated 100V transformer with three power taps (30/15/7,5 W)

Order number: 1074

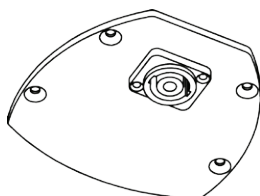

Plate with NL4

closed bottom plate with SpeakCON NL4 connector

Order number: 900109

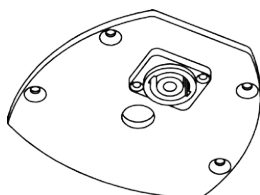

Plate with 3/8"- inlet thread with NL4

Bottom plate with 3/8"- inlet thread for mounting the speaker on a microphone stand with SpeakCON NL4 connector

Order number: 900107

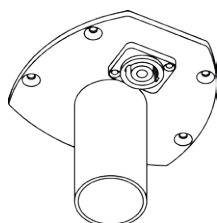

Plate with 35 mm flange and NL4

Bottom plate with 35 mm flange with thumbscrew for mounting on a distance rod and with SpeakCON NL4 connector

Order number: 900857

hd M2 datasheet

Accessories

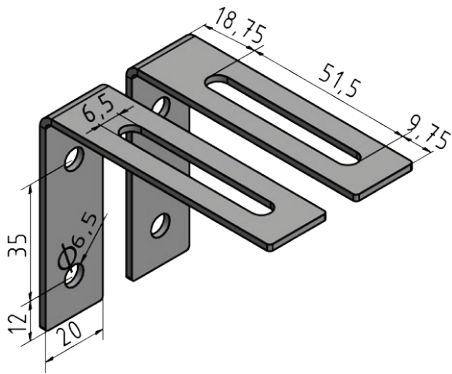

L-bracket wall mount-set

Discreet L-bracket set for extremely close mounting of the speaker to the wall. Side swivel with inclination up to 5°. The speakers housing plates are equipped with M6 inlet threads.

Incl. 2x M6x14 hexagon socket screws

Load capacity:	5 kg
Dimensions (W x H x D):	20 x 60 x 80 mm
Order number:	900106 (in RAL color of speaker)



Ball joint wall mount

Compact ball joint wall mount bracket for tilting up to 20° and pivoting of up to 180°.

Load capacity:	5 kg
Dimensions (W x H x D):	40 x 70 x 70 mm
Order number:	901101BLK (black RAL 9005) 901101W (white RAL 9010)