



hd C3CX

Commercial Stick

The **hd C3CX** is a passive 2 1/2-way miniature speaker equipped with two 3" woofers supporting a 3.5" woofer with a coaxially arranged 1" tweeter in a D'Appolito design with extended linear frequency response. The operation can be done via any power amplifier without DSP and makes the hd C3CX the optimal solution for decentralized or small sound reinforcement tasks such as in restaurants, conference rooms or theaters. The hd C3CX can be flexibly and easily installed permanently or can be used as a mobile ultra compact short throw speaker. Using the discreet ball joint wall mount, the hd C3CX can be easily swiveled and tilted or attached to the surface to be fixed extremely close and inconspicuous with the L-angle wall mount. Internal connection terminals ensure a tool-free and fast connection of the loudspeaker. For optimum adaptation to the room architecture, the loudspeaker can be customized in all RAL colors and special lengths. If wall mounting is not possible, the speaker can be used with the optional 3/8" inlet thread bottom plate and SpeakCON connector on a microphone stand.



Features

- Operation with any amplifier
- Integrated frequency and phase optimization
- elegant design
- precise and even sound emission
- Coverage pattern 80° x 80°
- excellent speech intelligibility
- extended frequency response for background music
- 100V version available

Applications

Restaurants, Bars, Airports, Train Stations, Home Theater, Conference Rooms, Hotels, A/V Installations, Multimedia Applications, Meeting Rooms, TV Studios, Churches

Model	hd C3CX
Order number	40355
Acoustic design	Coaxial, D'Appolito
Transducers	2x 3" woofers 1x 3,5" + 1" coaxial driver
Impedance	4 or 8 Ω, choose on order
Crossover	4 kHz
Coverage (hor x ver)	80° x 80°
Frequency range (-6dB)	100 Hz - 22 kHz
Sensitivity (1W / 1m)	90 dB
Power Rating AES / Peak	115 / 160 W
SPLmax @ 10% THD	112 dB
Enclosure	powder-coated aluminum profile black, steel grille with acoustic foam, connection terminal inside, cable inlet rear, incl. 2x M6 nuts
Optional Accessories	Speakon NL4 (Art. 900109) 3/8"- inlet thread + NL4 (Art. 900107) 35 mm flange + NL4 (Art. 900857) RAL color, wall mount, special length, weather protection, 100V
Weight	2 kg
Dimensions (W x H x D)	108 x 280 x 104 mm



hd C3CX datasheet

Dimensions [mm]

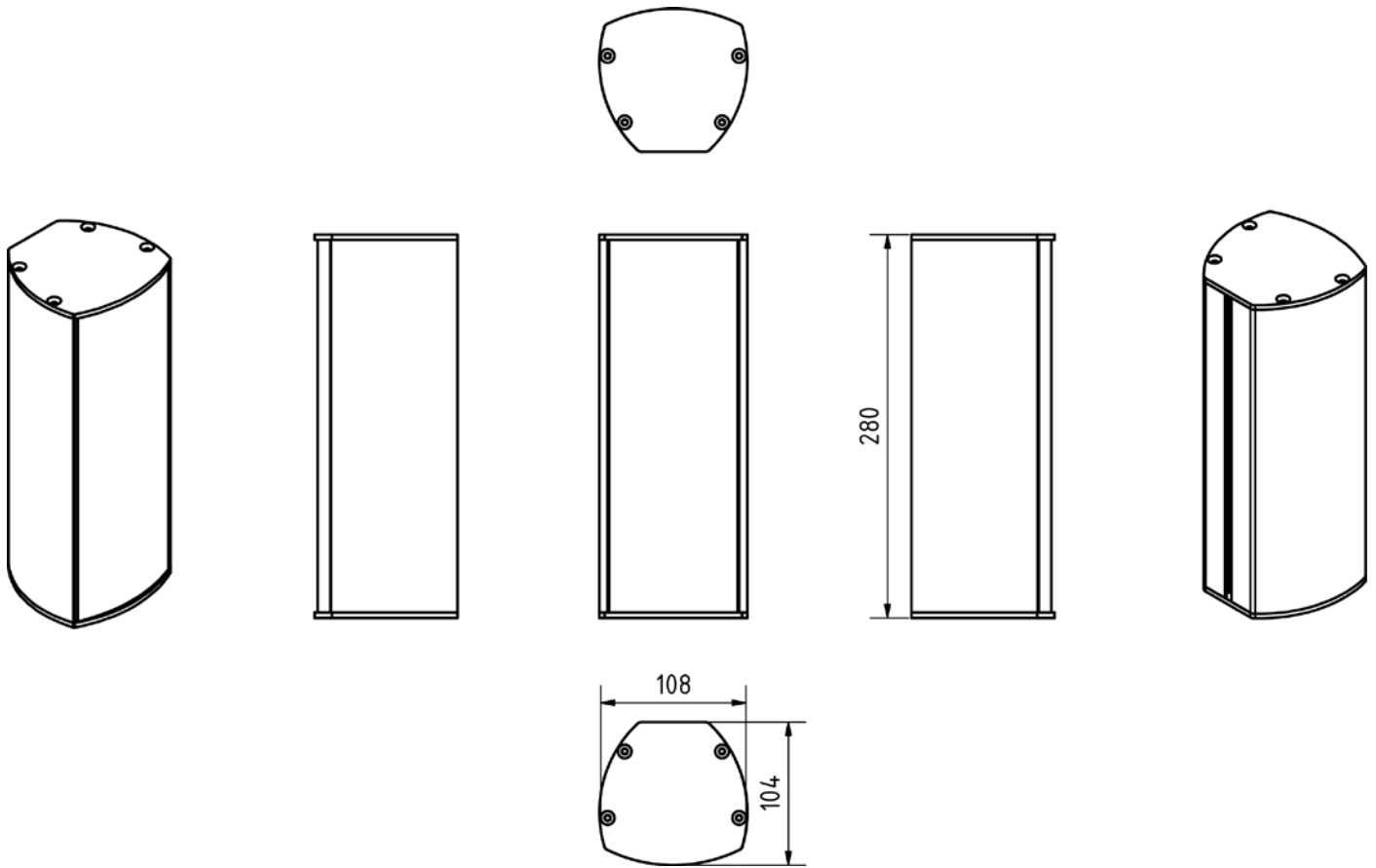

Impedance

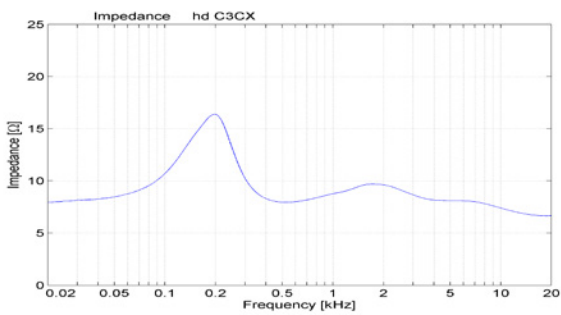

Horizontal Isobars

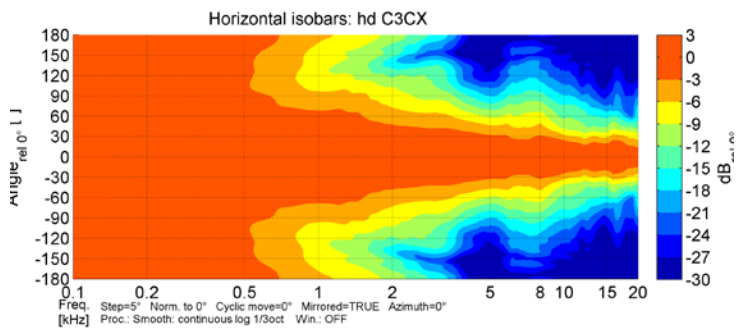

Frequency response with DSP preset

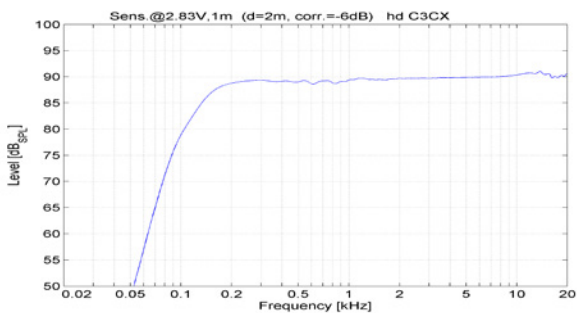

Vertical Isobars

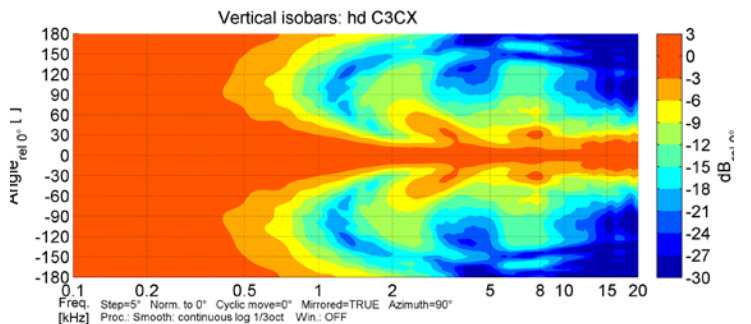

hd C3CX datasheet

Accessories

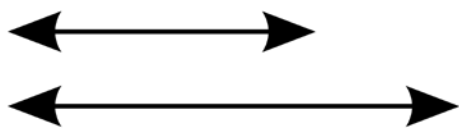

Special length

Special length of the speaker according to customer requirements

Order number: 40712 (up to 1000 mm total length)
40713 (up to 2000 mm total length)



RAL-Color

Special color per article according to RAL color chart

Order number: 1070



Weather protection

Impregnation against weather influences

Order number: 4610



100V-Transformer

integrated 100V transformer with three power taps (30/15/7,5 W)

Order number: 1074

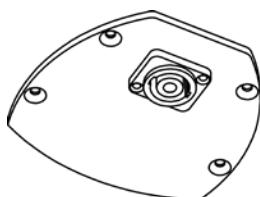

Plate with NL4

closed bottom plate with SpeakCON NL4 connector

Order number: 900109

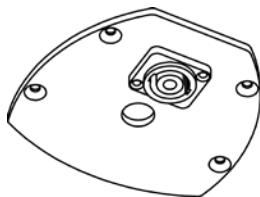

Plate with 3/8"- inlet thread with NL4

bottom plate with 3/8"- inlet thread for mounting the speaker on a microphone stand with SpeakCON NL4 connector

Order number: 900107

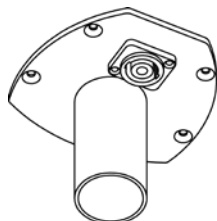

Plate with 35 mm flange and NL4

bottom plate with 35 mm flange with thumbscrew for mounting on a distance rod and with SpeakCON NL4 connector

Order number: 900857



Mounting adapter for mobile applications

use with inclinable stand adapter 19780 for easy and quick installation with two thumbscrews in mobile applications

Order number: 900851 (black RAL 9005)

hd C3CX datasheet

Accessories



Stand adaptor 19780

Tripod adapter for tilting up to 30 ° on a 35 mm tripod

Load capacity: 15 kg
Dimensions (W x H x D): 59 x 87 x 131 mm
Order number: 900856 (black RAL 9005)



Wall mount 24471

wall distance 110 mm, laterally swiveling with inclination up to 30 °

Load capacity: 15 kg
Dimensions (W x H x D): 90 x 160 x 110 mm
Order number: 900851BLK (black RAL 9005)
900851W (white RAL 9010)

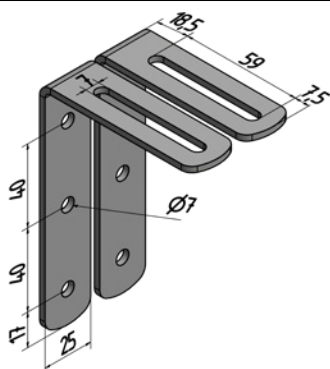

L-bracket wall mount-set

Discreet L-bracket set for extremely close mounting of the speaker to the wall. Side swivel with inclination up to 5°. The speakers housing plates are equipped with M6 inlet threads.
Incl. 2x M6x14 hexagon socket screws

Load capacity: 5 kg
Dimensions (W x H x D): 20 x 60 x 80 mm
Order number: 900106 (in RAL color of speaker)



Ball joint wall mount

Compact ball joint wall mount bracket for tilting up to 20° and pivoting of up to 180°.

Load capacity: 5 kg
Dimensions (W x H x D): 40 x 70 x 70 mm
Order number: 901101BLK (black RAL 9005)
901101W (white RAL 9010)



UniBracket CCX

Adapter for CCX speaker for horizontal mounting to the front edge of the stage or monitor application. Wall mounting also possible incl. thumbscrew

Dimensions (W x H x D): 90 x 42 x 130 mm
Order number: 900870BLK (schwarz RAL 9005)
900870W (weiß RAL 9010)